

Article number: 201242830

Description: E+G
Pin with axial lock GN 124.2-8-30

Measures

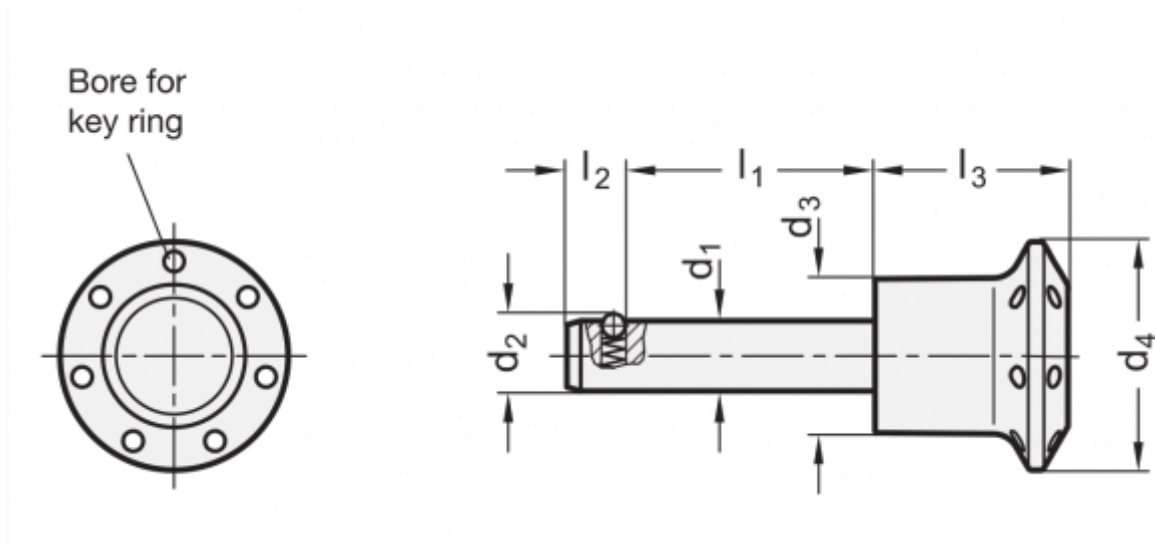

Axial grasping power on pins N = 15	= 8	$l_2 = 6.3$
Bore for pin D12	= 8	$l_3 = 22.5$
d1	= 8	
d2	= 8.7	
d3	= 14.5	
d4	= 25	
Dividing power (double) in kN	= 40	
l1	= 30	